

# CS 561, NP-Hardness and Approximation Algorithms

Jared Saia  
University of New Mexico

# Today's Outline

- P, NP and NP-Hardness
- Reductions
- Approximation Algorithms

# Efficient Algorithms

- Q: What is a minimum requirement for an algorithm to be efficient?
- A: A long time ago, theoretical computer scientists decided that a minimum requirement of any efficient algorithm is that it runs in polynomial time:  $O(n^c)$  for some constant  $c$
- People soon recognized that not all problems can be solved in polynomial time but they had a hard time figuring out exactly which ones could and which ones couldn't

# NP-Hard Problems

- Q: How to determine those problems which can be solved in polynomial time and those which can not
- Again a long time ago, Steve Cook and Dick Karp and others defined the class of *NP-hard* problems
- Most people believe that NP-Hard problems *cannot* be solved in polynomial time, even though so far nobody has *proven* a super-polynomial lower bound.
- What we do know is that if *any* NP-Hard problem can be solved in polynomial time, they *all* can be solved in polynomial time.

# Circuit Satisfiability

- **Circuit satisfiability** is a good example of a problem that we don't know how to solve in polynomial time
- In this problem, the input is a *boolean circuit*: a collection of and, or, and not gates connected by wires
- We'll assume there are no loops in the circuit (so no delay lines or flip-flops)

# Circuit Satisfiability

- The input to the circuit is a set of  $m$  boolean (true/false) values  $x_1, \dots, x_m$
- The output of the circuit is a single boolean value
- Given specific input values, we can calculate the output in polynomial time using depth-first search and evaluating the output of each gate in constant time

# Circuit Satisfiability

- The circuit satisfiability problem asks, given a circuit, whether there is an input that makes the circuit output **True**
- In other words, does the circuit always output false for any collection of inputs
- Nobody knows how to solve this problem faster than just trying all  $2^m$  possible inputs to the circuit but this requires exponential time
- On the other hand nobody has ever proven that this is the best we can do!

# Example

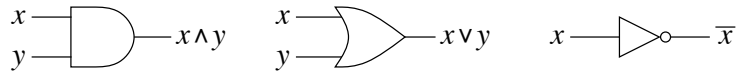

An and gate, an or gate, and a not gate.

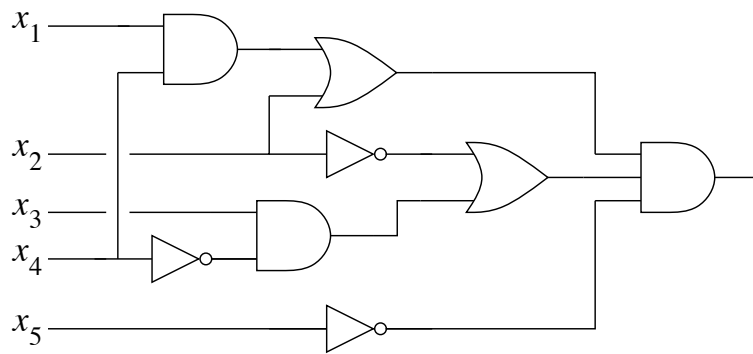

A boolean circuit. Inputs enter from the left, and the output leaves to the right.



# Classes of Problems

We can characterize many problems into three classes:

- **P** is the set of yes/no problems that can be solved in polynomial time. Intuitively P is the set of problems that can be solved “quickly”
- **NP** is the set of yes/no problems with the following property: If the answer is yes, then there is a *proof* of this fact that can be checked in polynomial time
- **co-NP** is the set of yes/no problems with the following property: If the answer is no, then there is a *proof* of this fact that can be checked in polynomial time

# NP

- **NP** is the set of yes/no problems with the following property: If the answer is yes, then there is a *proof* of this fact that can be checked in polynomial time
- Intuitively NP is the set of problems where we can verify a **Yes** answer quickly if we have a solution in front of us
- For example, circuit satisfiability is in NP since if the answer is yes, then any set of  $m$  input values that produces the **True** output is a proof of this fact (and we can check this proof in polynomial time)

## P, NP, and co-NP

- If a problem is in P, then it is also in NP — to verify that the answer is yes in polynomial time, we can just throw away the proof and recompute the answer from scratch
- Similarly, any problem in P is also in co-NP
- In this sense, problems in P can only be easier than problems in NP and co-NP

## Examples

- The problem: “For a certain circuit and a set of inputs, is the output **True**?” is in P (and in NP and co-NP)
- The problem: “Does a certain circuit have an input that makes the output **True**?” is in NP
- The problem: “Does a certain circuit always have output true for any input?” is in co-NP

# P Examples

Most problems we've seen in this class so far are in P including:

- “Does there exist a path of distance  $\leq d$  from  $u$  to  $v$  in the graph  $G$ ?”
- “Does there exist a minimum spanning tree for a graph  $G$  that has cost  $\leq c$ ?”
- “Does there exist an alignment of strings  $s_1$  and  $s_2$  which has cost  $\leq c$ ?”

# NP Examples

There are also several problems that are in NP (but probably not in P) including:

- **Circuit Satisfiability**
- **Coloring:** “Can we color the vertices of a graph  $G$  with  $c$  colors such that every edge has two different colors at its endpoints ( $G$  and  $c$  are inputs to the problem)”
- **Clique:** “Is there a clique of size  $k$  in a graph  $G$ ?” ( $G$  and  $k$  are inputs to the problem)
- **Hamiltonian Path:** “Does there exist a path for a graph  $G$  that visits every vertex exactly once?”

# The \$1 Million Question

- The most important question in computer science (and one of the most important in mathematics) is: “Does  $P=NP$ ?”
- Nobody knows.
- Intuitively, it *seems* obvious that  $P \neq NP$ ; in this class you’ve seen that some problems can be very difficult to solve, even though the solutions are obvious once you see them
- But nobody has proven that  $P \neq NP$

## NP and co-NP

- Notice that the definition of NP (and co-NP) is not symmetric.
- Just because we can verify every yes answer quickly doesn't mean that we can check no answers quickly
- For example, as far as we know, there is no short proof that a boolean circuit is *not* satisfiable
- In other words, we know that Circuit Satisfiability is in NP but we don't know if its in co-NP



# Conjectures

- We conjecture that  $P \neq NP$  and that  $NP \neq co-NP$
- Here's a picture of what we *think* the world looks like:

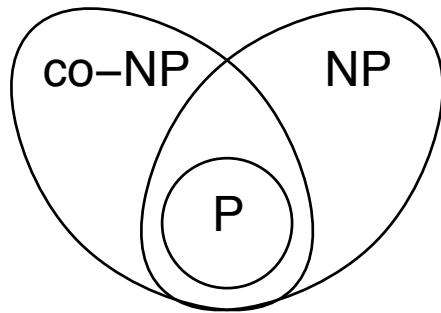

## NP-Hard

- A problem  $\Pi$  is **NP-hard** if a polynomial-time algorithm for  $\Pi$  would imply a polynomial-time algorithm for *every problem in NP*
- In other words:  **$\Pi$  is NP-hard means that if  $\Pi$  can be solved in polynomial time then  $P=NP$**
- In other words: if we can solve one particular NP-hard problem quickly, then we can quickly solve *any* problem whose solution is quick to check (using the solution to that one special problem as a subroutine)
- If you tell your boss that a problem is NP-hard, it's like saying: "Not only can't I find an efficient solution to this problem but neither can all these other very famous people." (you could then seek to find an approximation algorithm for your problem)

# NP-Complete

- A problem is *NP-Easy* if it is in NP
- A problem is *NP-Complete* if it is NP-Hard and NP-Easy
- In other words, a problem is NP-Complete if it is in NP but is at least as hard as all other problems in NP.
- If anyone finds a polynomial-time algorithm for even one NP-complete problem, then that would imply a polynomial-time algorithm for *every* NP-Complete problem
- *Thousands* of problems have been shown to be NP-Complete, so a polynomial-time algorithm for one (i.e. all) of them is incredibly unlikely

# Example

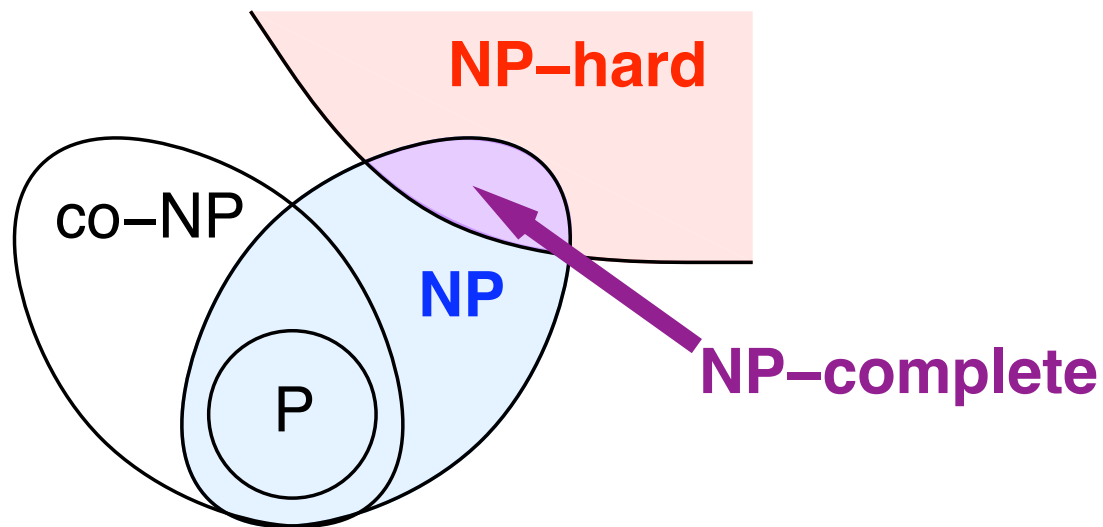

A more detailed picture of what we *think* the world looks like.

# Proving NP-Hardness

- In 1971, Steve Cook proved the following theorem: **Circuit Satisfiability is NP-Hard**
- Thus, one way to show that a problem  $A$  is NP-Hard is to show that if you can solve it in polynomial time, then you can solve the Circuit Satisfiability problem in polynomial time.
- This is called a *reduction*. We say that we *reduce* from Circuit Satisfiability to problem  $A$
- This implies that problem  $A$  is “as difficult as” Circuit Satisfiability.

# SAT

- Consider the *formula satisfiability* problem (aka *SAT*)
- The input to SAT is a boolean formula like

$$(a \vee b \vee c \vee \bar{d}) \Leftrightarrow ((b \wedge \bar{c}) \vee \overline{(\bar{a} \Rightarrow d)} \vee (c \neq a \wedge b)),$$

- The question is whether it is possible to assign boolean values to the variables  $a, b, c, \dots$  so that the formula evaluates to TRUE
- To show that SAT is NP-Hard, we need to show that we can use a solution to SAT to solve Circuit Satisfiability

# The Reduction

- *Given a boolean circuit, we can transform it into a boolean formula by creating new output variables for each gate and then just writing down the list of gates separated by AND*
- This simple algorithm is the reduction
- For example, we can transform the example circuit into a formula as follows:

## Example

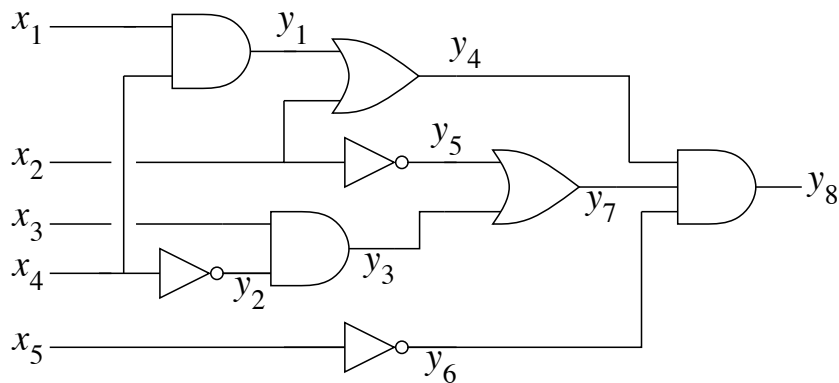

$$(y_1 = x_1 \wedge x_4) \wedge (y_2 = \overline{x_4}) \wedge (y_3 = x_3 \wedge y_2) \wedge (y_4 = y_1 \vee x_2) \wedge (y_5 = \overline{x_2}) \wedge (y_6 = \overline{x_5}) \wedge (y_7 = y_3 \vee y_5) \wedge (y_8 = y_4 \wedge y_7 \wedge y_6) \wedge y_8$$

A boolean circuit with gate variables added, and an equivalent boolean formula.



# Reduction Picture

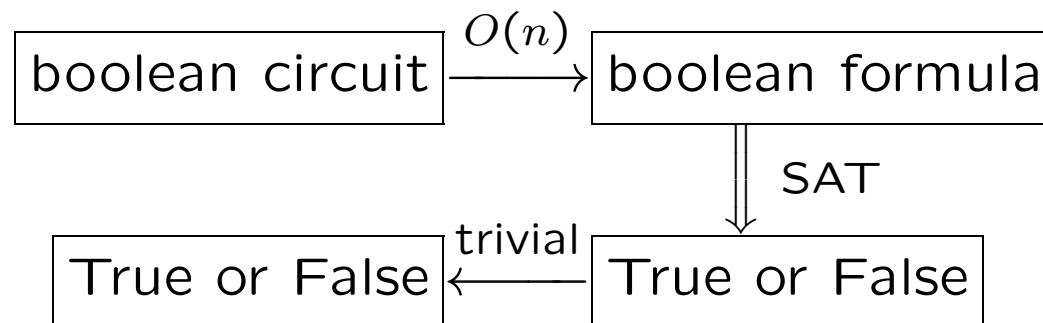

# Reduction

- The original circuit is satisfiable iff the resulting formula is satisfiable
- We can transform any boolean circuit into a formula in linear time using DFS and the size of the resulting formula is only a constant factor larger than the size of the circuit
- Thus we've shown that if we had a polynomial-time algorithm for SAT, then we'd have a polynomial-time algorithm for Circuit Satisfiability (and this would imply that  $P=NP$ )
- This means that SAT is NP-Hard

# Showing NP-Completeness

- We've shown that SAT is NP-Hard, to show that it is NP-Complete, we now must also show that it is in NP
- In other words, we must show that if the given formula is satisfiable, then there is a proof of this fact that can be checked in polynomial time
- To prove that a boolean formula is satisfiable, we only have to specify an assignment to the variables that makes the formula true (this is the "proof" that the formula is true)
- Given this assignment, we can check it in linear time just by reading the formula from left to right, evaluating as we go
- So we've shown that SAT is NP-Hard and that SAT is in NP, thus SAT is NP-Complete

## Take Away

- In general to show a problem is NP-Complete, we first show that it is in NP and then show that it is NP-Hard
- To show that a problem is in NP, we just show that when the problem has a “yes” answer, there is a proof of this fact that can be checked in polynomial time. Such a proof is sometimes called a *certificate*
- To show that a problem is NP-Hard, we show that if we could solve it in polynomial time, then we could solve some other NP-Hard problem in polynomial time (this is called a reduction)

## 3-SAT

- A boolean formula is in *conjunctive normal form* (CNF) if it is a conjunction (and) of several *clauses*, each of which is the disjunction (or) of several *literals*, each of which is either a variable or its negation. For example:

$$\overbrace{(a \vee b \vee c \vee d)}^{\text{clause}} \wedge (b \vee \bar{c} \vee \bar{d}) \wedge (\bar{a} \vee c \vee d) \wedge (a \vee \bar{b})$$

- A *3CNF* formula is a CNF formula with exactly three literals per clause
- The 3-SAT problem is just: “Is there any assignment of variables to a 3CNF formula that makes the formula evaluate to true?”

# 3-SAT

- 3-SAT is just a restricted version of SAT
- Surprisingly, 3-SAT also turns out to be NP-Complete
- 3-SAT is very useful in proving NP-Hardness results for other problems, we'll see how it can be used to show that CLIQUE is NP-Hard

# SAT to 3-SAT

- To convert an arbitrary formula into 3-SAT form, need to deal with:
  - Clauses with just 1 or 2 literals
    - Replicate literals to bring the number up to 3:  $(\neg x_1 \vee x_5) \rightarrow (\neg x_1 \vee \neg x_1 \vee x_5)$
  - Clauses with 4 or more literals
    - Chaining: split into multiple clauses, using new "linking" literals
    - E.g.:  $(x_1 \vee x_2 \vee x_3 \vee x_4) \rightarrow (x_1 \vee x_2 \vee z) \wedge (\neg z \vee x_3 \vee x_4)$
    - Replace  $(x_1 \vee \dots \vee x_k)$  with  $k - 2$  new clauses  $(x_1 \vee x_2 \vee z_1) \wedge (\neg z_1 \vee x_3 \vee z_2) \wedge (\neg z_2 \vee x_4 \vee z_3) \wedge \dots \wedge (\neg z_{k-1} \vee x_{k-1} \vee x_k)$
- Can do all this in polynomial time

# CLIQUE

- The problem CLIQUE asks “Is there a clique of size  $k$  in a graph  $G$ ?”
- Example graph with clique of size 4:

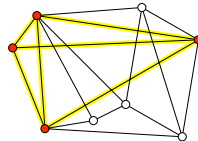

- We'll show that Clique is NP-Hard using a reduction from 3-SAT. (the proof that Clique is in NP is left as an exercise)



# The Reduction

- Given a 3-CNF formula  $F$ , we construct a graph  $G$  as follows.
- The graph has one node for each instance of each literal in the formula
- Two nodes are connected by an edge if: (1) they correspond to literals in different clauses and (2) those literals do not contradict each other

# Reduction Example

- Let  $F$  be the formula:  $(a \vee b \vee c) \wedge (b \vee \bar{c} \vee \bar{d}) \wedge (\bar{a} \vee c \vee d) \wedge (a \vee \bar{b} \vee \bar{d})$
- This formula is transformed into the following graph:

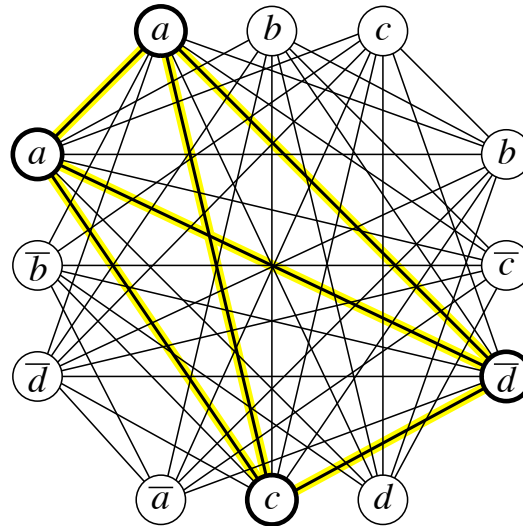

(look for the edges that *aren't* in the graph)

# Reduction

- Let  $F$  have  $k$  clauses. Then  $G$  has a clique of size  $k$  iff  $F$  has a satisfying assignment. The proof:
- **$k$ -clique  $\implies$  satisfying assignment:** If the graph has a clique of  $k$  vertices, then each vertex must come from a different clause. To get the satisfying assignment, we declare that each literal in the clique is true. Since we only connect non-contradictory literals with edges, this declaration assigns a consistent value to several of the variables. There may be variables that have no literal in the clique; we can set these to any value we like.
- **satisfying assignment  $\implies k$ -clique:** If we have a satisfying assignment, then we can choose one literal in each clause that is true. Those literals form a  $k$ -clique in the graph.

# Reduction Picture

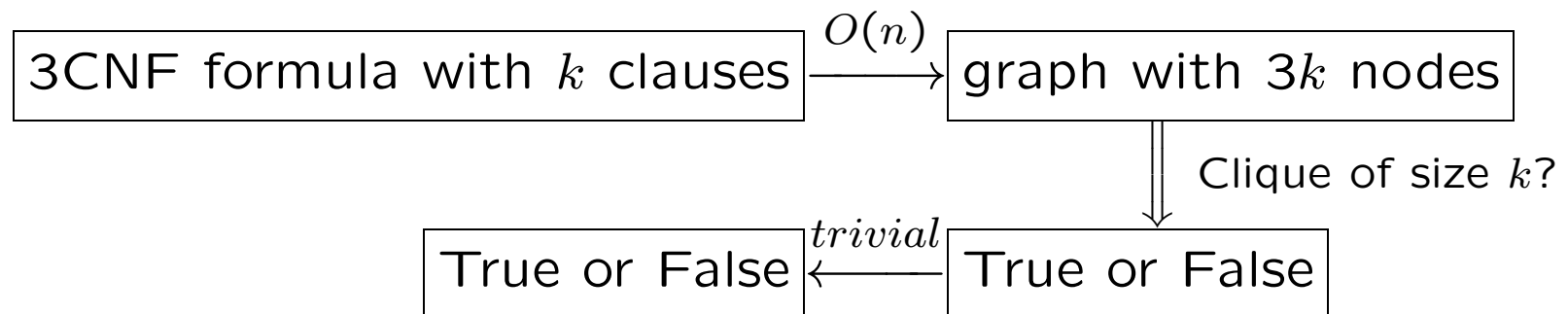

## In-Class Exercise

Consider the formula:  $(a \vee b) \wedge (b \vee \bar{c}) \wedge (c \vee \bar{b})$

- Q1: Transform this formula into a graph,  $G$ , using the reduction just given.
- Q2: What is the maximum clique size in  $G$ ? Give the vertices in this maximum clique.

# CLIQUE is NP-Complete

- To show CLIQUE is NP-Complete, must now show it is in NP
- An efficiently checkable proof (aka certificate) that there is a CLIQUE of size  $k$  in a graph  $G = (V, E)$  is just a subset  $V'$  of  $V$  of size  $k$
- To check this proof, need to go through every pair of nodes  $u$  and  $v$  in  $V'$  and check that  $(u, v) \in E$ .
- This just takes polynomial time in the input size.

# Independent Set

- Independent Set is the following problem: “Does there exist a set of  $k$  vertices in a graph  $G$  with no edges between them?”
- It is easy to show that independent set is NP-Hard by a reduction from CLIQUE (will do now in class).
- Thus we can now use Independent Set to show that other problems are NP-Hard

# Vertex Cover

- A *vertex cover* of a graph is a set of vertices that touches every edge in the graph
- The problem *Vertex Cover* is: “Does there exist a vertex cover of size at most  $k$  in a graph  $G$ ?”
- We can prove this problem is NP-Hard by an easy reduction from Independent Set



## Key Observation

- Key Observation: If  $I$  is an independent set in a graph  $G = (V, E)$ , then  $V - I$  is a vertex cover.
- Thus, there is an independent set of size  $k$  iff there is a vertex cover of size  $|V| - k$ .
- For the reduction, we want to show that a polynomial time algorithm for Vertex Cover can give a polynomial time algorithm for Independent Set

## The Reduction

- We are given a graph  $G = (V, E)$  and a value  $k$  and we must determine if there is an independent set of size  $k$  in  $G$ .
- To do this, we ask if there is a vertex cover of size  $|V| - k$  in  $G$ .
- If so then we return that there *is* an independent set of size  $k$  in  $G$
- If not, we return that there *is not* an independent set of size  $k$  in  $G$

# The Reduction

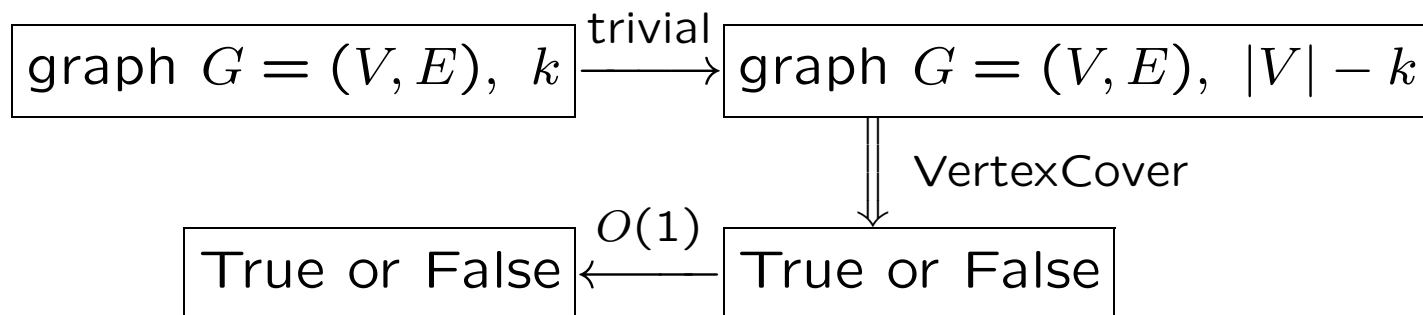

# Graph Coloring

- A  $c$ -coloring of a graph  $G$  is a map  $C : V \rightarrow \{1, 2, \dots, c\}$  that assigns one of  $c$  “colors” to each vertex so that every edge has two different colors at its endpoints
- The graph coloring problem is: “Does there exist a  $c$ -coloring for the graph  $G$ ?”
- Even when  $c = 3$ , this problem is hard. We call this problem *3Colorable* i.e. “Does there exist a 3-coloring for the graph  $G$ ?”

# 3Colorable

- To show that 3Colorable is NP-hard, we will reduce from 3Sat
- This means that we want to show that a polynomial time algorithm for 3Colorable can give a polynomial time algorithm for 3Sat
- Recall that the 3-SAT problem is just: “Is there any assignment of variables to a 3CNF formula that makes the formula evaluate to true?”
- And a 3CNF formula is just a conjunct of a bunch of clauses, each of which contains exactly 3 variables e.g.

$$\overbrace{(a \vee b \vee c)}^{\text{clause}} \wedge (b \vee \bar{c} \vee \bar{d}) \wedge (\bar{a} \vee c \vee d) \wedge (a \vee \bar{b} \vee d)$$

# Reduction

- We are given a 3-CNF formula,  $F$ , and we must determine if it has a satisfying assignment
- To do this, we produce a graph as follows
- The graph contains one *truth* gadget, one *variable* gadget for each variable in the formula, and one *clause* gadget for each clause in the formula

# The Truth Gadget

- The truth gadget is just a triangle with three vertices  $T$ ,  $F$  and  $X$ , which intuitively stand for **True**, **False**, and **other**
- Since these vertices are all connected, they must have different colors in any 3-coloring
- For the sake of convenience, we will name those colors **True**, **False**, and **Other**
- Thus when we say a node is colored “True”, we just mean that it’s colored the same color as the node  $T$

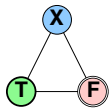

## The Variable Gadgets

- The variable gadget for a variable  $a$  is also a triangle joining two new nodes labeled  $a$  and  $\bar{a}$  to node  $X$  in the truth gadget
- Node  $a$  must be colored either “True” or “False”, and so node  $\bar{a}$  must be colored either “False” or “True”, respectively.

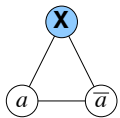

- The variable gadget ensures that each of the literals is colored either “True” or “False”



# The Clause Gadgets

- Each clause gadget joins three literal nodes to node  $T$  in the truth gadget using five new unlabelled nodes and ten edges (as in the figure)
- This clause gadget ensures that at least one of the three literal nodes in each clause is colored “True”
- Example clause gadget for the clause  $a \vee b \vee \bar{c}$

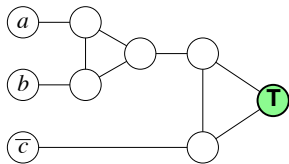

# Example

Consider the formula  $(a \vee b \vee c) \wedge (b \vee \bar{c} \vee \bar{d}) \wedge (\bar{a} \vee c \vee d) \wedge (a \vee \bar{b} \vee \bar{d})$ .  
Following is the graph created by the reduction:

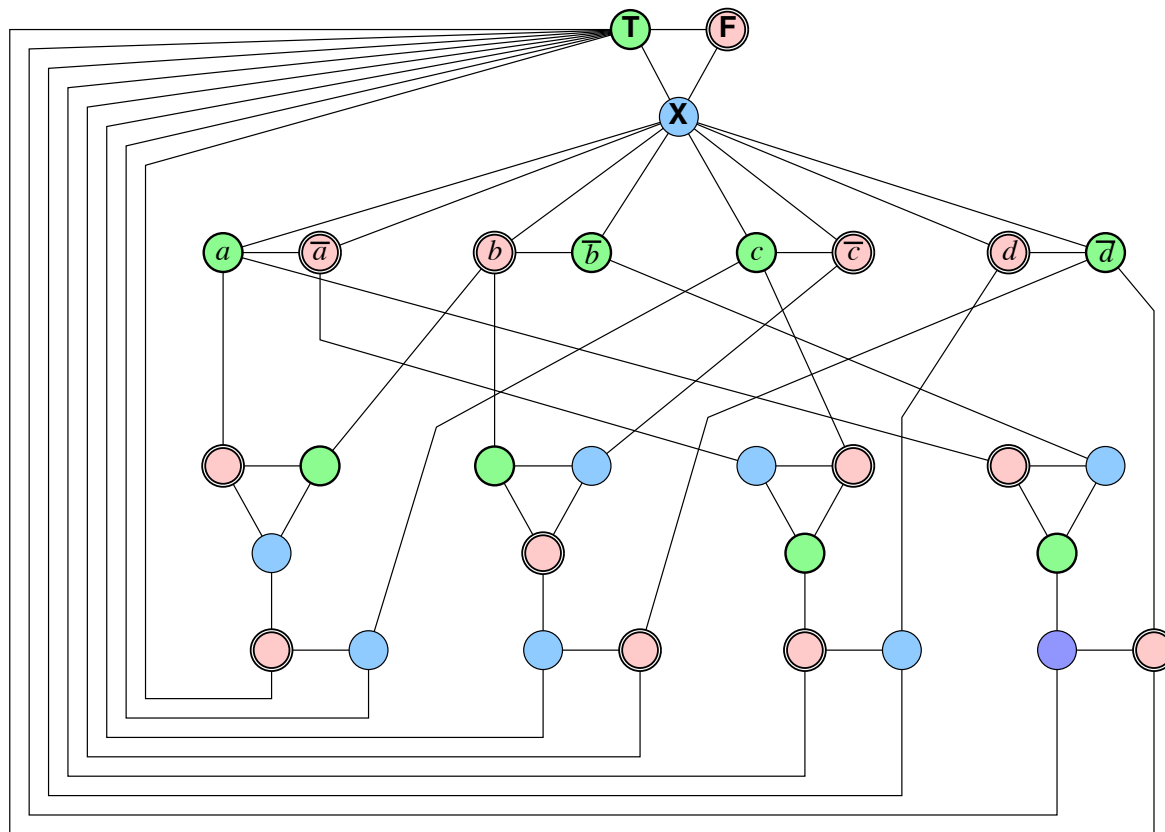

## Example

- Note that the 3-coloring of this example graph corresponds to a satisfying assignment of the formula
- Namely,  $a = c = \text{True}$ ,  $b = d = \text{False}$ .
- Note that the final graph contains only *one* node  $T$ , only *one* node  $F$ , only *one* node  $\bar{a}$  for each variable  $a$  and so on

## Correctness

- The proof of correctness for this reduction is direct
- If the graph is 3-colorable, then we can extract a satisfying assignment from any 3-coloring, since at least one of the three literal nodes in every clause gadget is colored “True”
- Conversely, if the formula is satisfiable, then we can color the graph according to any satisfying assignment

# Reduction Picture

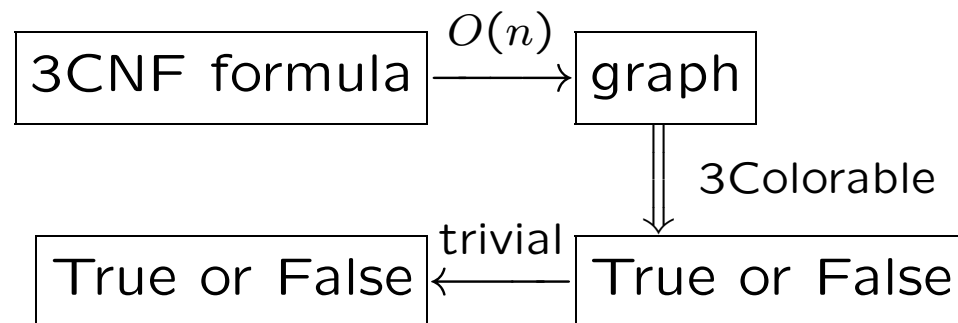

## Wrap Up

- We've just shown that if 3Colorable can be solved in polynomial time then 3-SAT can be solved in polynomial time
- This shows that 3Colorable is NP-Hard
- To show that 3Colorable is in NP, we just need to note that we can easily verify that a graph has been correctly 3-colored in linear time: just compare the endpoints of every edge
- Thus, 3Coloring is NP-Complete.
- This implies that the more general graph coloring problem is also NP-Complete

## In-Class Exercise

Consider the problem *4Colorable*: “Does there exist a 4-coloring for a graph  $G$ ?”

- Q1: Show this problem is in NP by showing that there exists an efficiently verifiable proof of the fact that a graph is 4 colorable.
- Q2: Show the problem is NP-Hard by a reduction from the problem *3Colorable*. In particular, show the following:
  - Given a graph  $G$ , you can create a graph  $G'$  such that  $G'$  is 4-colorable iff  $G$  is 3-colorable.
  - Creating  $G'$  from  $G$  takes polynomial time

Note: You've now shown that *4Colorable* is NP-Complete!

# Hamiltonian Cycle

- A *Hamiltonian Cycle* in a graph is a cycle that visits every vertex exactly once (note that this is very different from an *Eulerian cycle* which visits every *edge* exactly once)
- The Hamiltonian Cycle problem is to determine if a given graph  $G$  has a Hamiltonian Cycle
- We will show that this problem is NP-Hard by a reduction from the vertex cover problem.



## The Reduction

- To do the reduction, we need to show that we can solve Vertex Cover in polynomial time if we have a polynomial time solution to Hamiltonian Cycle.
- Given a graph  $G$  and an integer  $k$ , we will create another graph  $G'$  such that  $G'$  has a Hamiltonian cycle iff  $G$  has a vertex cover of size  $k$
- As for the last reduction, our transformation will consist of putting together several “gadgets”

# Edge Gadget and Cover Vertices

- For each edge  $(u, v)$  in  $G$ , we have an *edge gadget* in  $G'$  consisting of twelve vertices and fourteen edges, as shown below

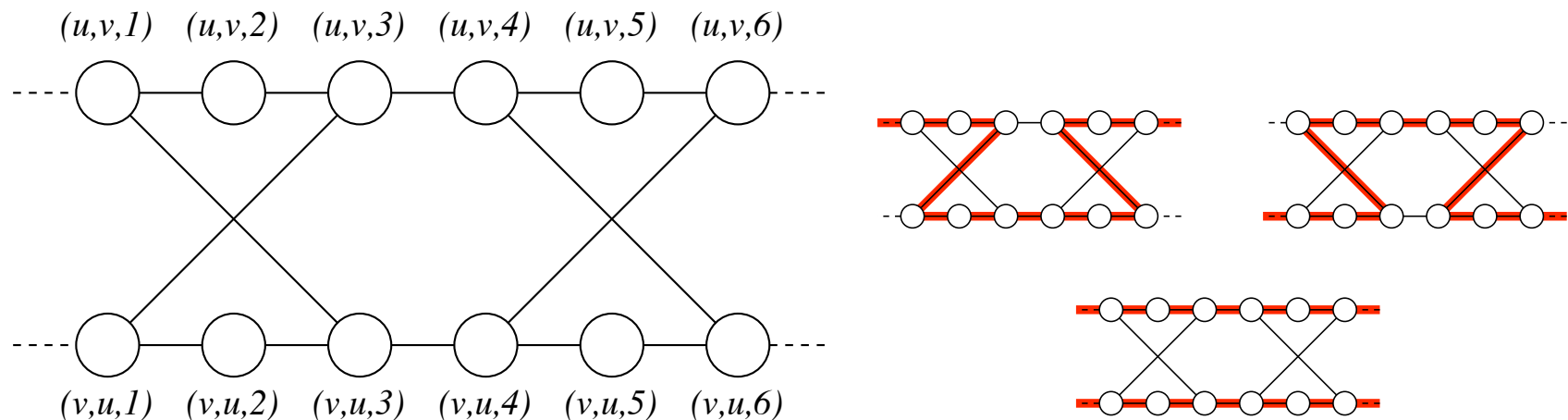

An edge gadget for  $(u, v)$  and the only possible Hamiltonian paths through it.

## Edge Gadget

- The four corner vertices  $(u, v, 1)$ ,  $(u, v, 6)$ ,  $(v, u, 1)$ , and  $(v, u, 6)$  each have an edge leaving the gadget
- A Hamiltonian cycle can only pass through an edge gadget in one of the three ways shown in the figure
- These paths through the edge gadget will correspond to one or both of the vertices  $u$  and  $v$  being in the vertex cover.

## Cover Vertices

- $G'$  also contains  $k$  *cover vertices*, simply numbered 1 through  $k$

## Vertex Chains

- For each vertex  $u$  in  $G$ , we string together all the edge gadgets for edges  $(u, v)$  into a single *vertex chain* and then connect the ends of the chain to all the cover vertices
- Specifically, suppose  $u$  has  $d$  neighbors  $v_1, v_2, \dots, v_d$ . Then  $G'$  has the following edges:
  - $d - 1$  edges between  $(u, v_i, 6)$  and  $(u, v_{i+1}, 1)$  (for all  $i$  between 1 and  $d - 1$ )
  - $k$  edges between the cover vertices and  $(u, v_1, 1)$
  - $k$  edges between the cover vertices and  $(u, v_d, 6)$

## The Reduction

- It's not hard to prove that if  $\{v_1, v_2, \dots, v_k\}$  is a vertex cover of  $G$ , then  $G'$  has a Hamiltonian cycle
- To get this Hamiltonian cycle, we start at cover vertex 1, traverse through the vertex chain for  $v_1$ , then visit cover vertex 2, then traverse the vertex chain for  $v_2$  and so forth, until we eventually return to cover vertex 1
- Conversely, one can prove that any Hamiltonian cycle in  $G'$  alternates between cover vertices and vertex chains, and that the vertex chains correspond to the  $k$  vertices in a vertex cover of  $G$

Thus,  $G$  has a vertex cover of size  $k$  iff  $G'$  has a Hamiltonian cycle

## The Reduction

- The transformation from  $G$  to  $G'$  takes at most  $O(|V|^2)$  time, so the Hamiltonian cycle problem is NP-Hard
- Moreover we can easily verify a Hamiltonian cycle in linear time, thus Hamiltonian Cycle is also in NP
- Thus Hamiltonian Cycle is NP-Complete

# Example

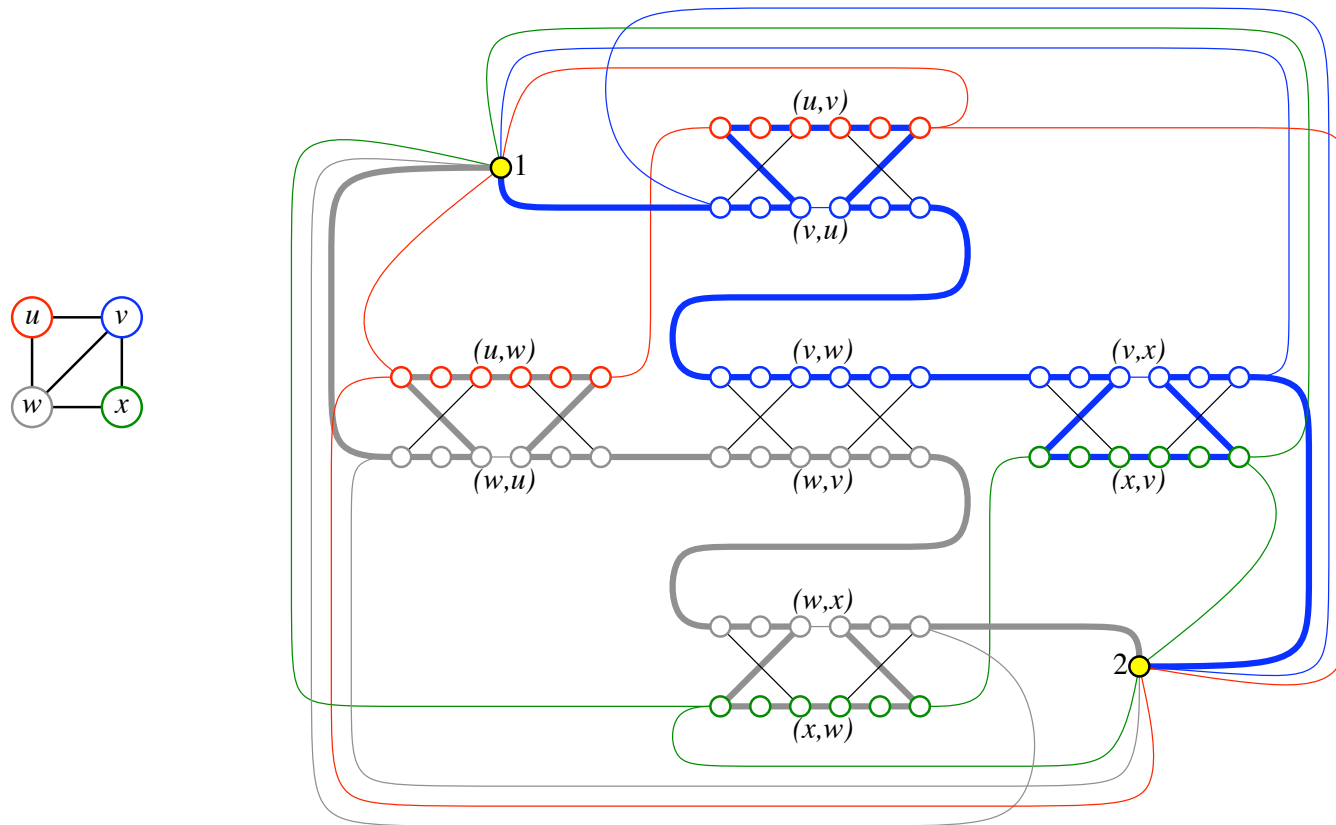

The original graph  $G$  with vertex cover  $\{v, w\}$ , and the transformed graph  $G'$  with a corresponding Hamiltonian cycle (bold edges).  
Vertex chains are colored to match their corresponding vertices.



# The Reduction

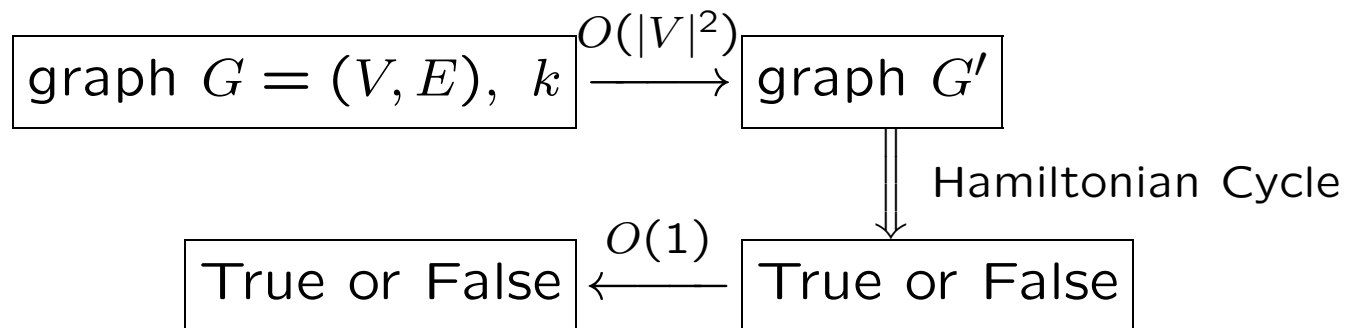

# Traveling Salesperson

- A problem closely related to Hamiltonian cycles is the famous *Traveling Salesperson Problem (TSP)*
- The TSP problem is: “Given a weighted graph  $G$ , find the shortest cycle that visits every vertex.
- Finding the shortest cycle is obviously harder than determining if a cycle exists at all, so since Hamiltonian Cycle is NP-hard, TSP is also NP-hard!

# NP-Hard Games

- In 1999, Richard Kaye proved that the solitaire game Minesweeper is NP-Hard, using a reduction from Circuit Satisfiability.
- Also recent efforts have shown that Tetris, Lemmings and Super Mario Brothers are NP-Hard

## Challenge Problem

- Consider the *optimization* version of, say, the graph coloring problem: “Given a graph  $G$ , what is the smallest number of colors needed to color the graph?” (Note that unlike the *decision* version of this problem, this is not a yes/no question)
- Show that the optimization version of graph coloring is also NP-Hard by a reduction from the decision version of graph coloring.
- Is the optimization version of graph coloring also NP-Complete?

## Challenge Problem

- Consider the problem 4SAT which is: “Is there any assignment of variables to a 4CNF formula that makes the formula evaluate to true?”
- Is this problem NP-Hard? If so, give a reduction from 3SAT that shows this. If not, give a polynomial time algorithm which solves it.

## Challenge Problem

- Consider the following problem: “Does there exist a clique of size 5 in some input graph  $G$ ?”
- Is this problem NP-Hard? If so, prove it by giving a reduction from some known NP-Hard problem. If not, give a polynomial time algorithm which solves it.

# Vertex Cover

- A *vertex cover* of a graph is a set of vertices that touches every edge in the graph
- The decision version of *Vertex Cover* is: “Does there exist a vertex cover of size  $k$  in a graph  $G$ ?” .
- We’ve proven this problem is NP-Hard by an easy reduction from Independent Set
- The *optimization* version of *Vertex Cover* is: “What is the minimum size vertex cover of a graph  $G$ ?”
- We can prove this problem is NP-Hard by a reduction from the decision version of Vertex Cover (left as an exercise).

# Approximating Vertex Cover

- Even though the optimization version of Vertex Cover is NP-Hard, it's possible to *approximate* the answer efficiently
- In particular, in polynomial time, we can find a vertex cover which is no more than 2 times as large as the minimal vertex cover



# Approximation Algorithm

- The approximation algorithm does the following until  $G$  has no more edges:
- It chooses an arbitrary edge  $(u, v)$  in  $G$  and includes both  $u$  and  $v$  in the cover
- It then removes from  $G$  all edges which are incident to either  $u$  or  $v$

# Approximation Algorithm

```
Approx-Vertex-Cover(G){
  C = {};
  E' = Edges of G;
  while(E' is not empty){
    let (u,v) be an arbitrary edge in E';
    add both u and v to C;
    remove from E' every edge incident to u or v;
  }
  return C;
}
```

## Analysis

- If we implement the graph with adjacency lists, each edge need be touched at most once
- Hence the run time of the algorithm will be  $O(|V| + |E|)$ , which is polynomial time
- First, note that this algorithm does in fact return a vertex cover since it ensures that every edge in  $G$  is incident to some vertex in  $C$
- Q: Is the vertex cover actually no more than twice the optimal size?

## Analysis

- Let  $A$  be the set of edges which are chosen in the first line of the while loop
- Note that no two edges of  $A$  share an endpoint
- Thus, *any* vertex cover must contain at least one endpoint of each edge in  $A$
- Thus,  $|C^*| \geq |A|$ , for an optimal cover  $C^*$
- Further,  $|C| = 2|A|$
- Thus,  $|C| \leq 2|C^*|$

Which means that the vertex cover found by the algorithm is no more than twice the size of an optimal vertex cover.

# TSP

- An optimization version of the TSP problem is: “Given a weighted graph  $G$ , what is the shortest Hamiltonian Cycle of  $G$ ?”
- This problem is NP-Hard by a reduction from Hamiltonian Cycle
- However, there is a 2-approximation algorithm for this problem if the edge weights obey the *triangle inequality*

# Triangle Inequality

- In many practical problems, it's reasonable to make the assumption that the weights,  $c$ , of the edges obey the *triangle inequality*
- The triangle inequality says that for all vertices  $u, v, w \in V$ :

$$c(u, w) \leq c(u, v) + c(v, w)$$

- In other words, the cheapest way to get from  $u$  to  $w$  is always to just take the edge  $(u, w)$
- In the real world, this is usually a pretty natural assumption. For example it holds if the vertices are points in a plane and the cost of traveling between two vertices is just the euclidean distance between them.

## Approximation Algorithm

- Given a weighted graph  $G$ , the algorithm first computes a MST for  $G$ ,  $T$ , and then arbitrarily selects a root node  $r$  of  $T$ .
- It then lets  $L$  be the list of the vertices visited in a depth first traversal of  $T$  starting at  $r$ .
- Finally, it returns the Hamiltonian Cycle,  $H$ , that visits the vertices in the order  $L$ .

# Approximation Algorithm

```
Approx-TSP(G){  
  T = MST(G);  
  L = the list of vertices visited in a depth first traversal  
    of T, starting at some arbitrary node in T;  
  H = the Hamiltonian Cycle that visits the vertices in the  
    order L;  
  return H;  
}
```



# Example Run

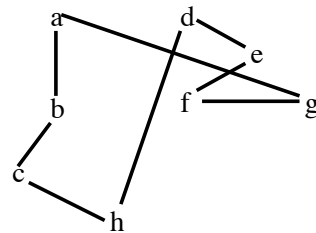
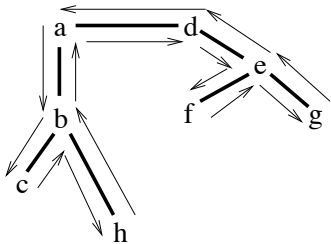
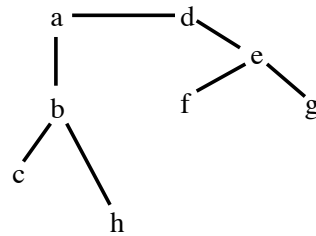
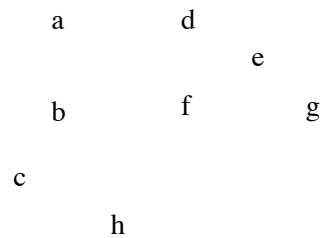

The top left figure shows the graph  $G$  (edge weights are just the Euclidean distances between vertices); the top right figure shows the MST  $T$ . The bottom left figure shows the depth first walk on  $T$ ,  $W = (a, b, c, b, h, b, a, d, e, f, e, g, e, d, a)$ ; the bottom right figure shows the Hamiltonian cycle  $H$  obtained by deleting repeat visits from  $W$ ,  $H = (a, b, c, h, d, e, f, g)$ .

## Analysis

- The first step of the algorithm takes  $O(|E| + |V| \log |V|)$  (if we use Prim's algorithm)
- The second step is  $O(|V|)$
- The third step is  $O(|V|)$ .
- Hence the run time of the entire algorithm is polynomial

## Analysis

An important fact about this algorithm is that: *the cost of the MST is less than the cost of the shortest Hamiltonian cycle.*

- To see this, let  $T$  be the MST and let  $H^*$  be the shortest Hamiltonian cycle.
- If we remove one edge from  $H^*$ , we have a spanning tree,  $T'$
- So,  $w(H^*) \geq w(T') \geq w(T)$
- Hence  $w(H^*) \geq w(T)$

## Analysis

- Now let  $P$  be a depth first traversal path of tree  $T$  which traverses each edge exactly twice
- In our example,  $P = (a, b, c, b, h, b, a, d, e, f, e, g, e, d, a)$
- So  $w(P) = 2w(T)$
- This implies that  $w(P) \leq 2w(H^*)$

## Analysis

- Unfortunately,  $P$  is not a Hamiltonian cycle since it visits some vertices more than once
- However, we can delete a visit to any vertex and the cost will not increase *because of the triangle inequality*. (The path without an intermediate vertex can only be shorter)
- By repeatedly applying this operation, we can remove from  $P$  all but the first visit to each vertex, without increasing the cost of  $P$ .
- In our example, this will give us the ordering  $H = (a, b, c, h, d, e, f, g)$

## Analysis

- By the last slide,  $w(H) \leq w(P)$ .
- So  $w(H) \leq w(P) = 2w(T) \leq 2w(H^*)$
- Thus,  $w(H) \leq 2w(H^*)$
- In other words, the Hamiltonian cycle found by the algorithm has cost no more than twice the shortest Hamiltonian cycle.

## Take Away

- Many real-world problems can be shown to not have an efficient solution unless  $P = NP$  (these are the NP-Hard problems)
- However, if a problem is shown to be NP-Hard, all hope is not lost!
- In many cases, we can come up with an provably good approximation algorithm for the NP-Hard problem.